

Half Houses

Short

Assembly Instructions



Important info and symbols.

You will need a sharp, narrow blade such as a utility or a hobby knife and some wood glue.

Some parts of the assembly has to be able to move. Be careful to not get glue into those areas, and allow glue to dry on parts before sliding them into place.

Parts are named sheet first, part second. Ex. 2.5 means sheet two, part 5. Parts that are the same, have the same number.

NB!!! Please do not print out these instructions unless absolutely necessary.

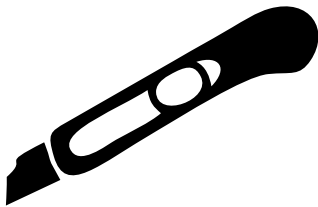

Cutting required



Glue required



Do not glue

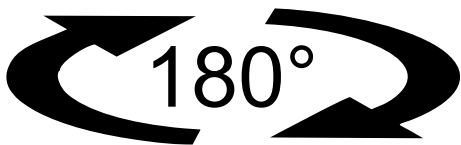

Turn horizontally

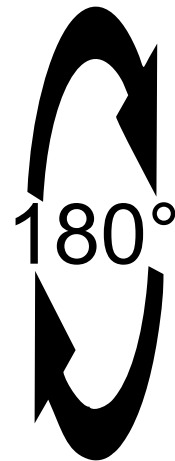

Turn vertically



Warning: Choking hazard. Kit contains small parts.
Not suitable for children under 3 years old.

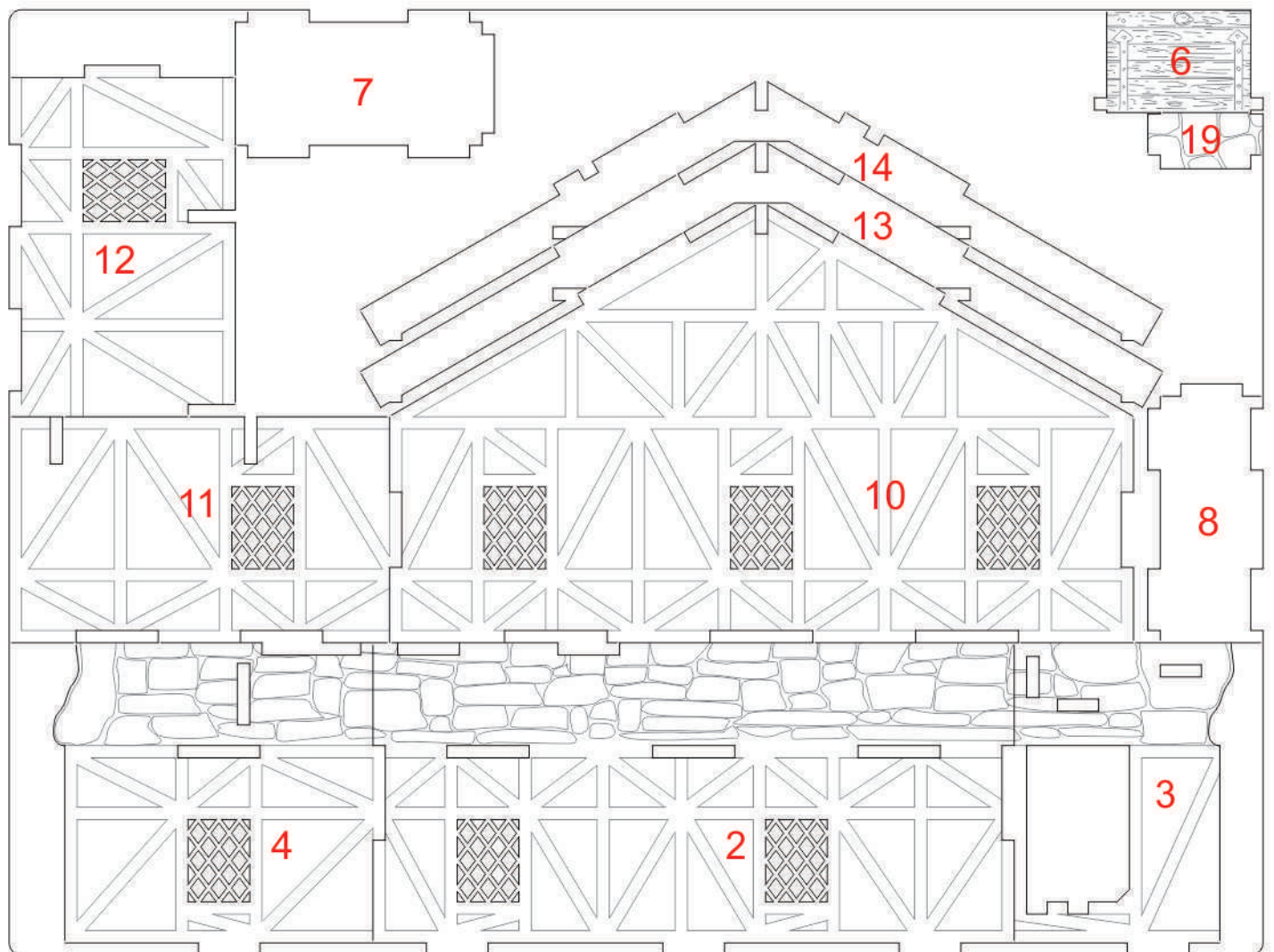
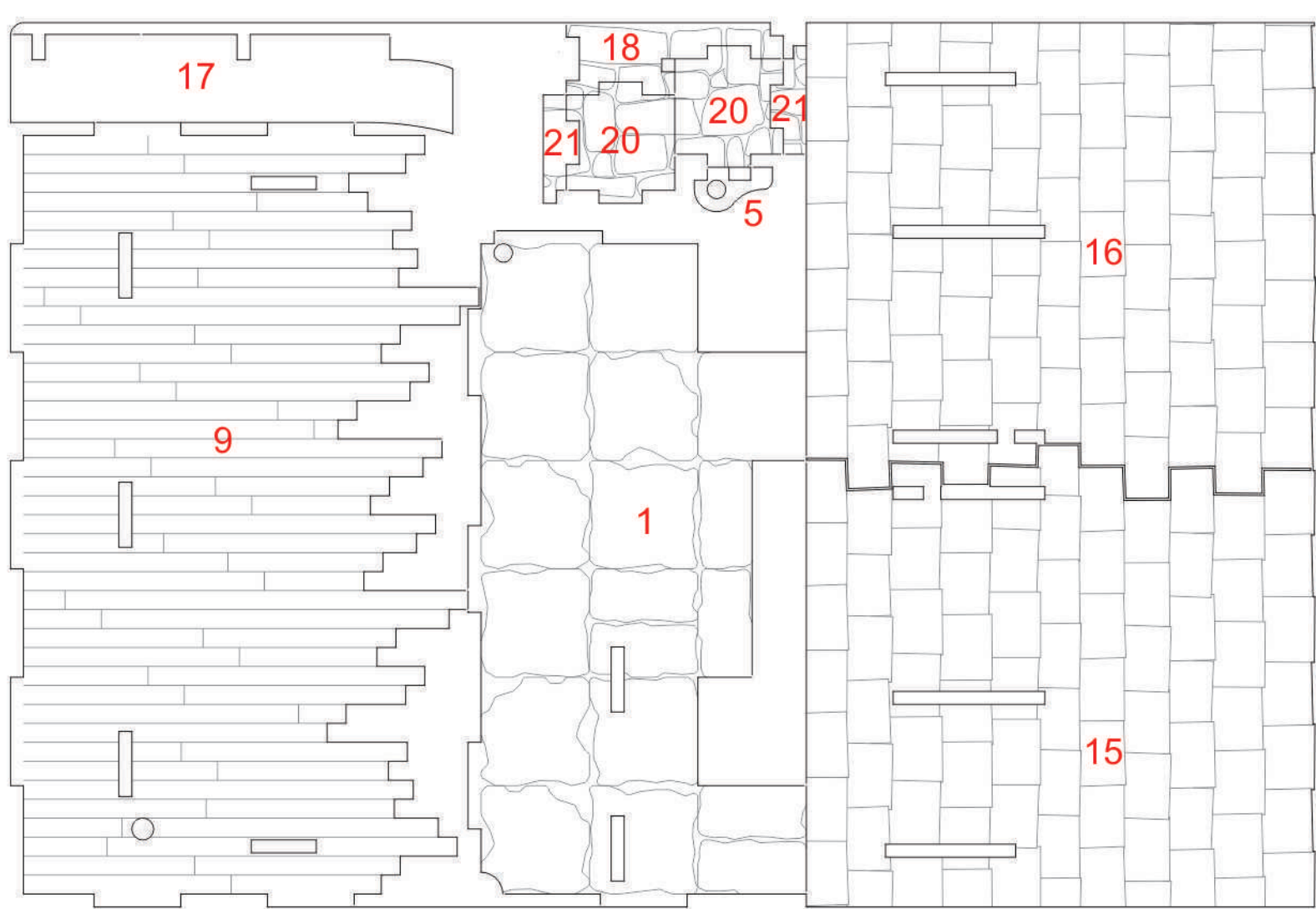

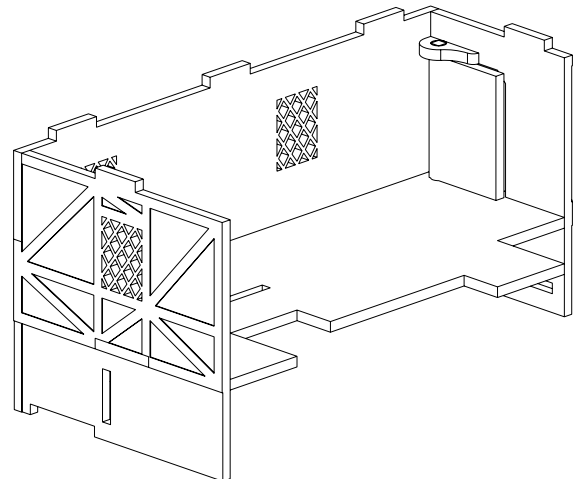
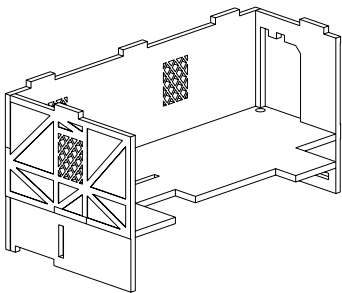
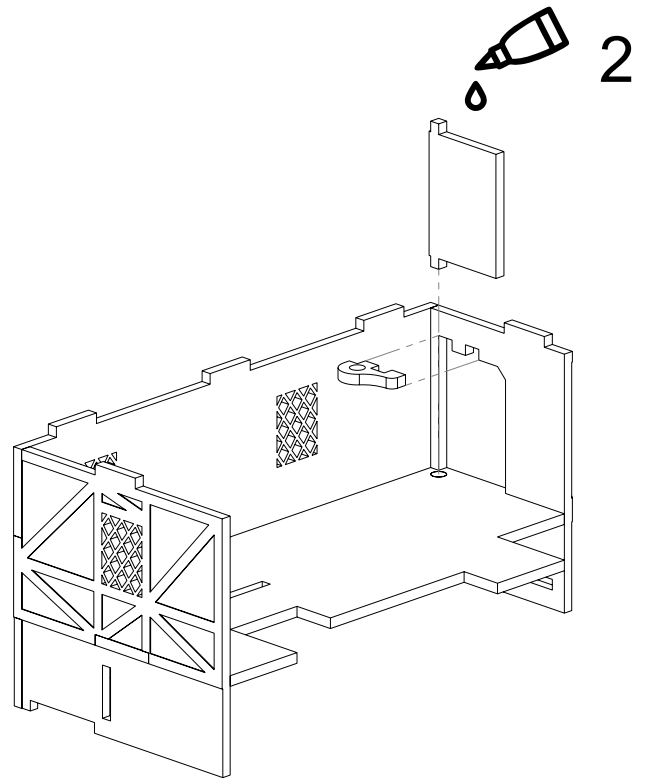
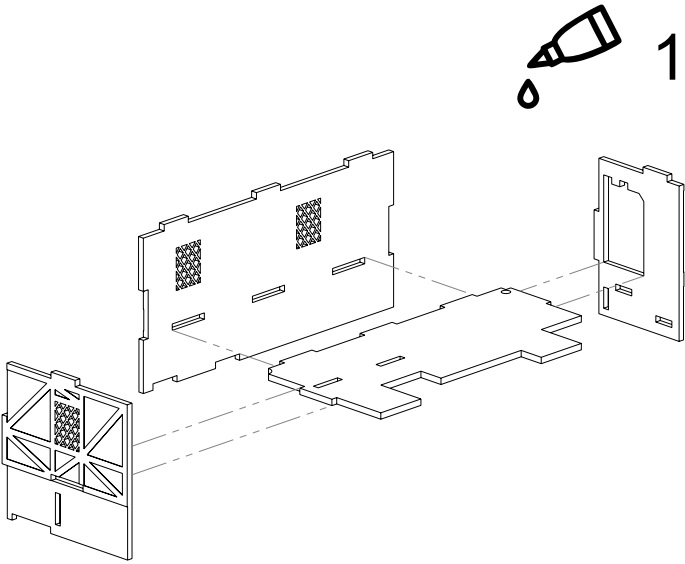
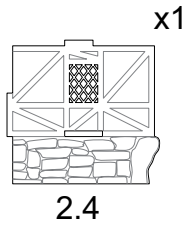
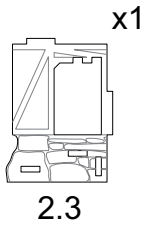
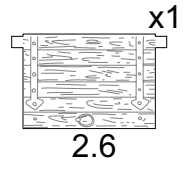
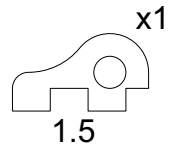
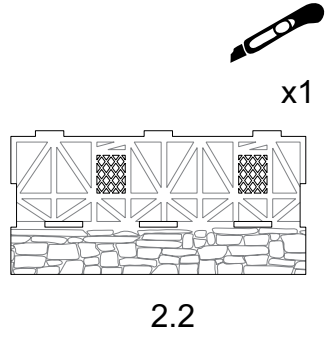
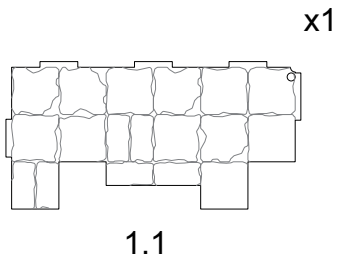

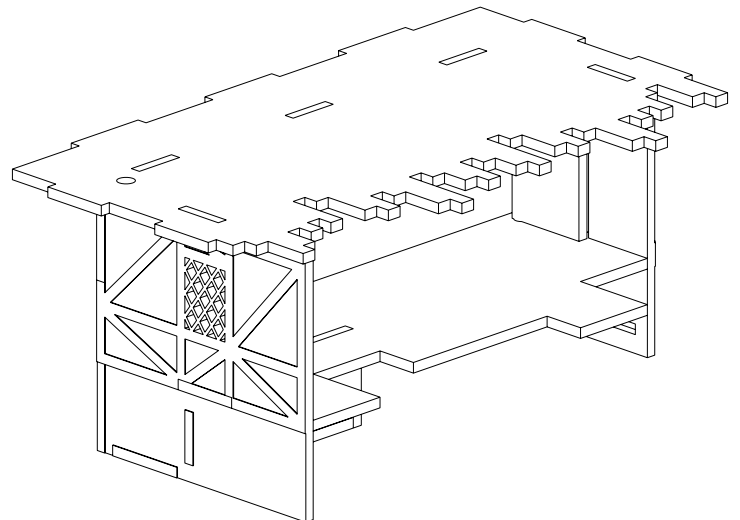
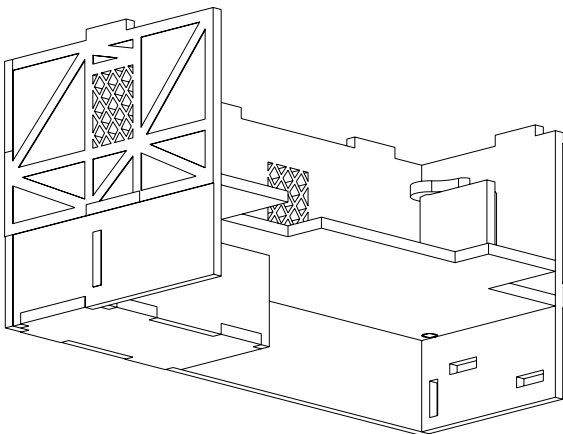
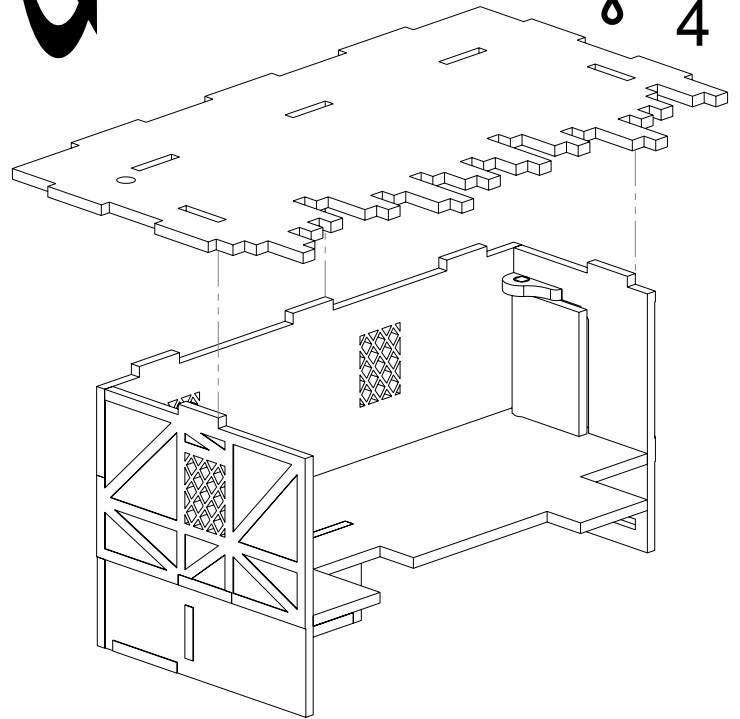
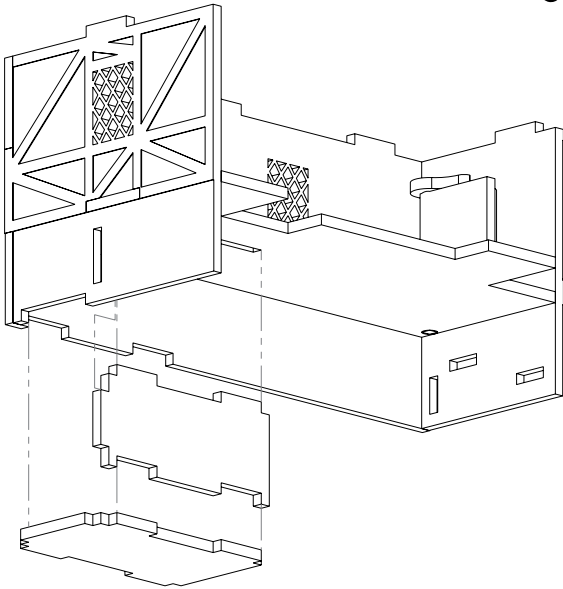
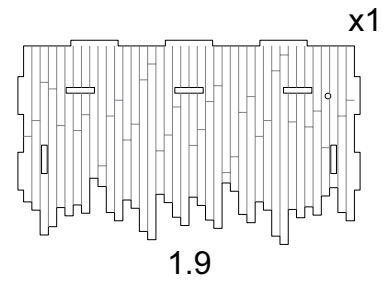
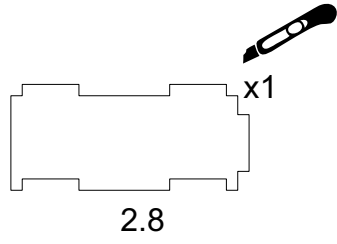
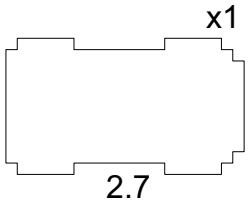



x1

x1

x1

x1

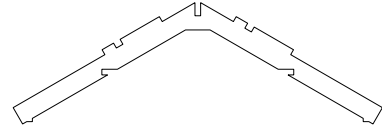
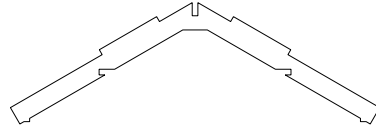
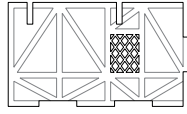
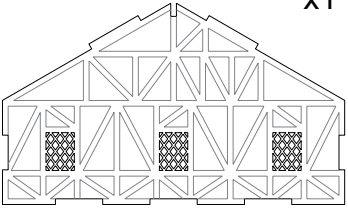

2.10

2.11

2.13

2.14

x1

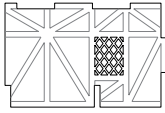

2.12

